



PURE
LIGHTING

2x2 Hybrid UVC Disinfection Fixture
with Intelli-Safe® Controls

PURE LIGHTING COMPANY

150 Pompton Plains Crossroad #4246 | Wayne, NJ 07474

Ph: (973) 915-3133 | Em: Info@Pure-Lighting.com

www.Pure-Lighting.com

CONTENTS

1. About Product.....	1
2. Control System.....	2
3. Installation Instructions.....	4
4. Parts Replacement Guide.....	5
5. Circuit Diagram.....	6
6. Product Safety Information (UVC Disclaimers).....	7

About Product

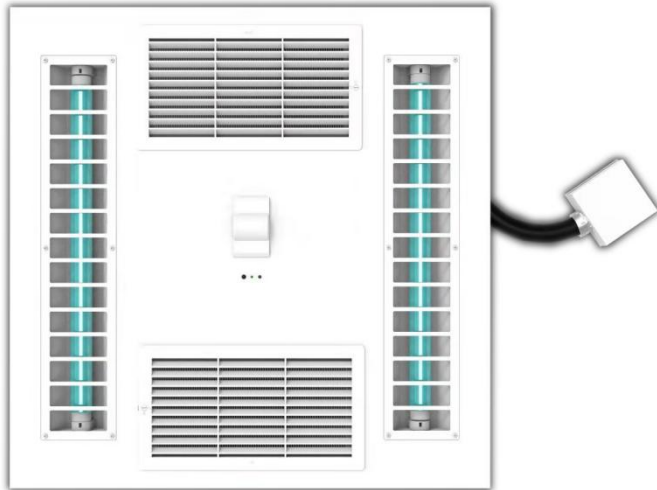

Model: PHTUVC2375IS

Size: 23.5" x 23.5" x 3.75"

Wattage: 75W \pm 5%

Voltage: 120-277V

Volume: 60CFM

Housing: SPCC

Control: Bluetooth & Switch

OVERVIEW:

The Hybrid light utilizes an UVC air treatment system and Bluetooth Intelli-Safe controls.

The internal and external UVC lamps have different control systems. The internal circulation sterilization system is controlled by switch, and the external direct sterilization system is controlled by Bluetooth Intelli-Safe controls.

The internal fan draws in untreated air, pushes it through a highly reflective UV chamber with ultraviolet light set at the wavelength of 253.7nm which inactivates bacteria, viruses, and fungi that pass over the lamp. The fan continues to push the air through the unit at approximately 60 CFM.

Work Flow Chart:

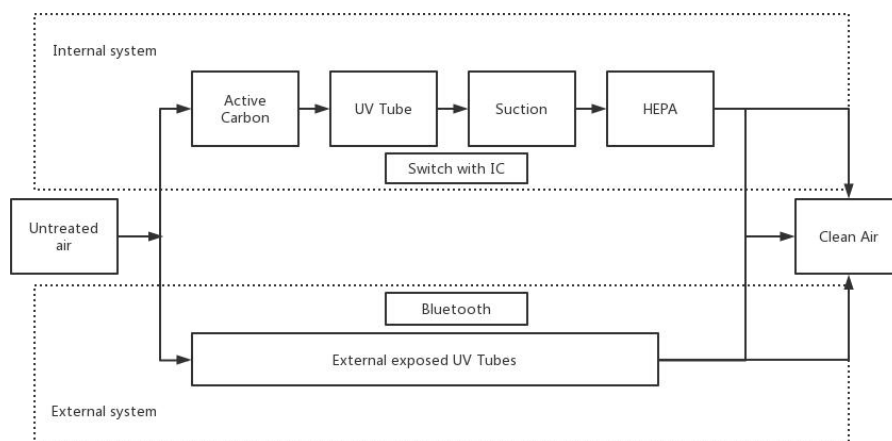

Control System

Internal System:

(1) 11W UVC Tube + Fans controlled by switch with IC Board. Designed for safe use during occupancy with people, pets, plants, and equipment.

The Function of the Indicator Light:

- When the product works normally, the indicator light is green.
- Report product internal system failure: If internal components (fans or internal UV Tube) do not work, the indicator light is on continuously with red light.
- Reminder to replace filter: After the cumulative timing reaches **3000h**, a red light blinking to prompt the replacement of the filter element.
- Data reset: After flashing, press and hold the reset key for **5s** to restart the timer.

External System:

(2) 25W UVC Tubes controlled by Bluetooth Intelli-Safe™ controls. Designed for effective and rapid surface + air disinfection in unoccupied spaces.

Function and Configuration:

App Features

 Grouping luminaires via mesh network

- Two levels: room & group
- Synchronization control

 7 types of scene options to set up:

- Generic Scenes
- Lux ON/OFF Scenes
- Daylight Harvest (Open loop)
- Daylight Harvest (Closed loop)
- Simple circadian rhythm without daylight sensor
- Advanced circadian rhythm with daylight sensor
- Time-based Scene

 Push switch configuration

 Detailed motion sensor settings

 **Bluetooth 5.0 SIG mesh**

 Schedule to run scenes based on time and date

 Astro timer (sunrise and sunset)

 Floorplan feature to simplify project planning

 Staircase function (master & slave)

 Status after re-powered on (memory against power loss)

 Offline commissioning

 Different permission levels via authority management

 Network sharing via QR code or keycode

 Remote control via gateway support

 Compatible with EnOcean range of wireless switches

 Device firmware update over-the-air (OTA)

 Continuous development in progress...

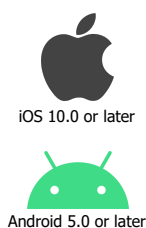

EnOcean
Self-powered IoT
Fully support
EnOcean switch

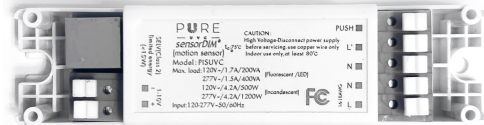

PISUVC is a 1-10V control base that works with a wide range of microwave and PIR sensor heads.

It is ideal for metal luminaire designs because the Bluetooth module is placed inside the sensor heads instead of the control base, so that the Bluetooth signal transmission is viable.

It is suitable for any typical indoor application such as office, classrooms, parking garages, warehouses and other commercial/industrial areas.

With Bluetooth wireless mesh networking, communication is made much easier without any hard wiring, which eventually adds value to luminaires and saves cost for projects. Device set up and commissioning is simple by using the **PURE uvc** app for iOS or Android devices.

Product Dimensions

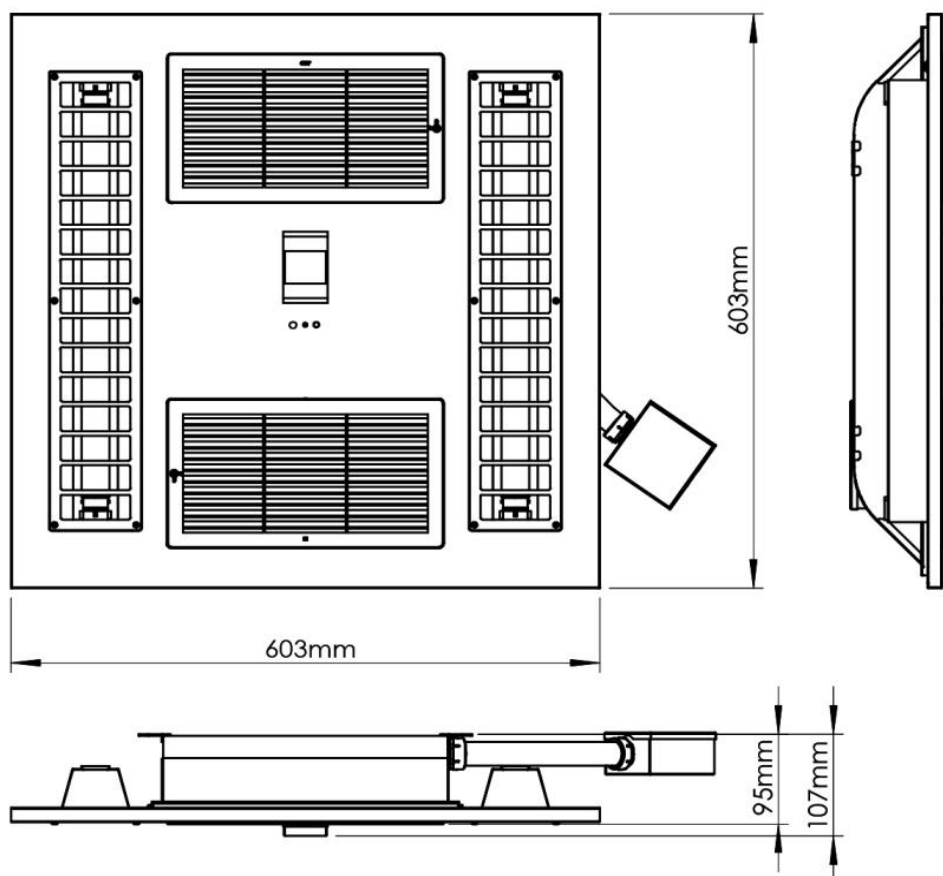

Installation Instructions

Recessed into Ceiling:

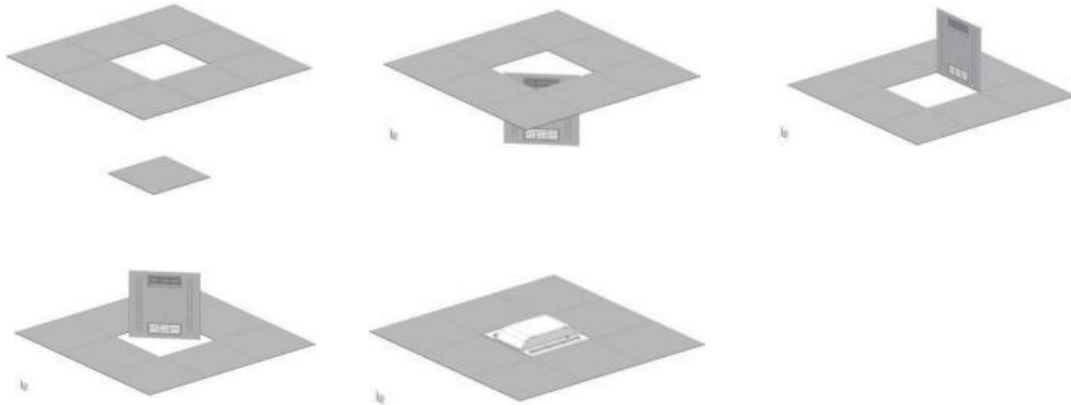

Suspended:

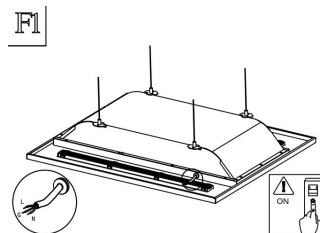
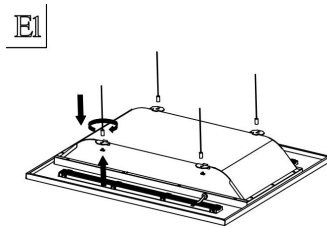
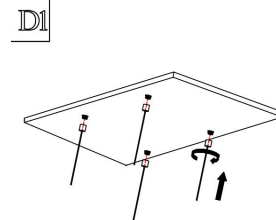
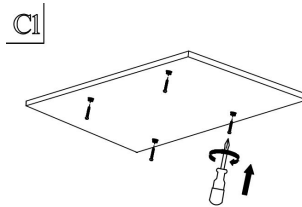
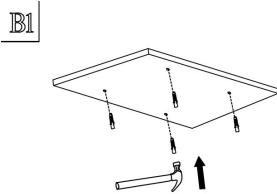
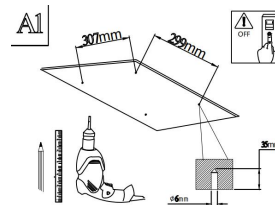
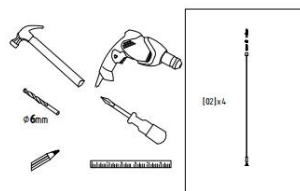

Tip:

Make sure the circuit is disconnected before installation.

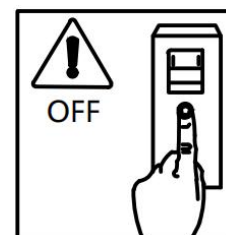

Surface mounted:

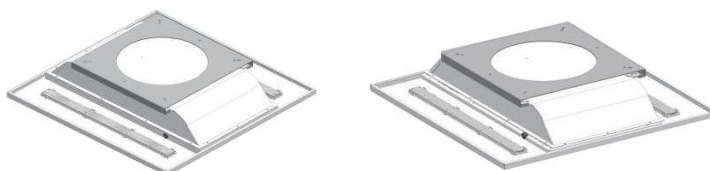

Parts replacement guide

Filter Replacement:

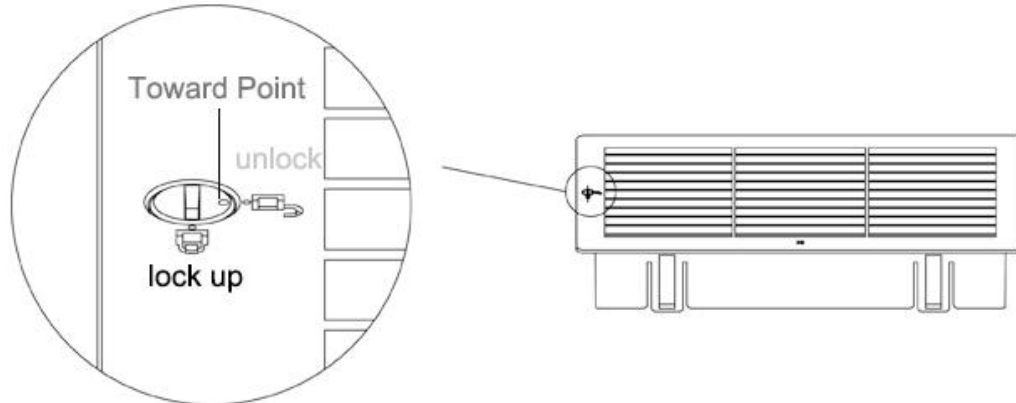

1. Rotary buckle: align the **"toward point"** with the **"unlock"** icon.
2. Remove the air inlet / outlet kit.
3. Remove the filter to be replaced from the kit.
4. Take a new filter and install it into the grid, *please don't forget to tear off the outer plastic bag.*
5. Place the kit in the corresponding mounting port, rotary buckle, align the **"toward point"** with the **"lock up"** icon.



Replace Internal UV Tube:

1. Remove the kit for the air **inlet**, rotate the tube angle and remove.
2. Install the UV tube into reflector steel.
3. Put UVC components inside the product, install the filter kit.



Tip: Make sure the circuit is disconnected before replacement.

Circuit diagram

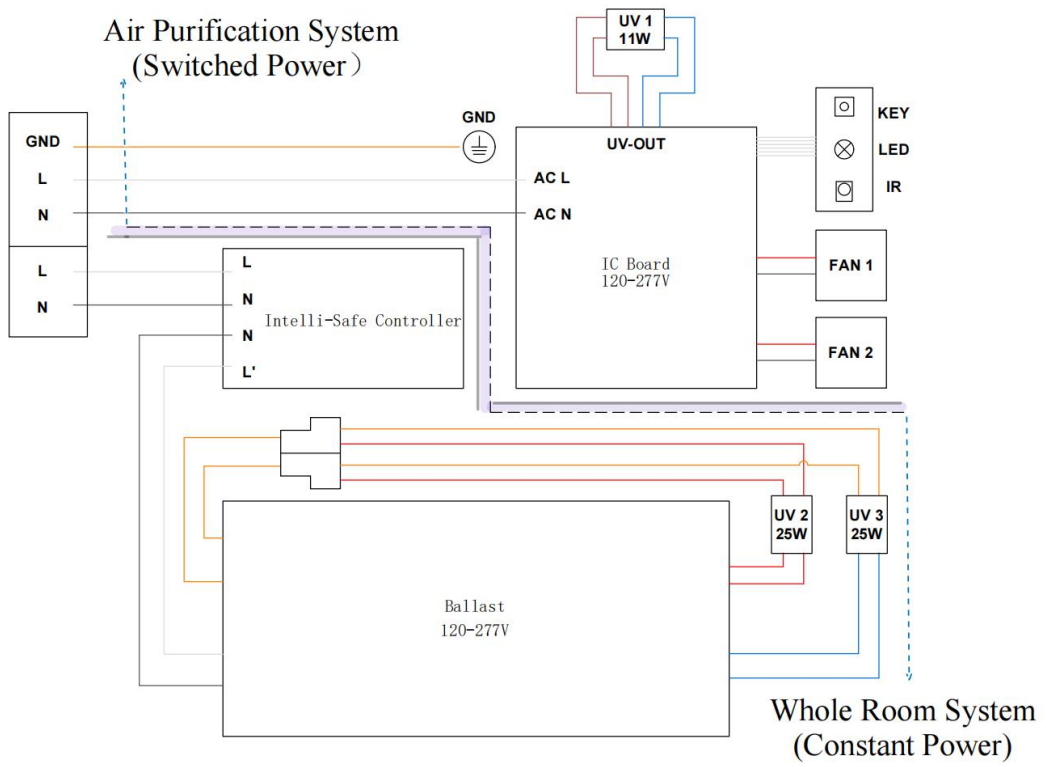

Product safety instructions(UVC Disclaimers)

IMPORTANT SAFETY INSTRUCTIONS

WARNING: FAILURE TO FOLLOW THESE INSTRUCTIONS AND WARNINGS MAY RESULT IN DEATH, SERIOUS INJURY OR SIGNIFICANT PROPERTY DAMAGE

– For your protection, read and follow the instructions and warnings on the carton before installing or maintaining this equipment. These instructions do not attempt to cover all installation and maintenance situations. If you do not understand these instructions or additional information is required, contact Pure Lighting Company or your local Pure Lighting Company Distributor. Save these instructions and warnings and deliver to owner after installation.

WARNING – UVC Light Hazard: UV lamp emissions may pose a safety and health hazard, particularly to the eyes and skin. The system in direct UVC treatment mode is NOT to be used in the presence of individuals without appropriate precautions, including the use of personal protective equipment for skin and eyes. Operator should use PPE including UVC Rated safety glasses, gloves, and should cover all exposed skin. Operator should never direct the UVC light toward him/herself or any other person. Use warning signs to prohibit individuals from entering the treatment area while the direct UVC light is activated. This product must be installed in accordance with the manufacturer's site planning recommendations, including location, dosage, and duration.

IT IS THE RESPONSIBILITY OF THE INSTALLER TO ENSURE THAT PERSONS WILL NOT BE EXPOSED TO EXCESSIVE UV OR OPTICAL RADIATION DURING EQUIPMENT OPERATION. THIS WILL REQUIRE THE INSTALLER TO CONDUCT AN ASSESSMENT OF ALL SITE AND EQUIPMENT SAFEGUARDS TO ENSURE THE SYSTEM IS OPERATING IN ACCORDANCE WITH THE SYSTEM MANUFACTURER'S INSTRUCTIONS AND SAFETY PROTOCOLS, INCLUDING AN ASSESSMENT OF IRRADIANCE OR ILLUMINANCE LEVELS IN THE SURROUNDING OCCUPIED SPACES.

WARNING – Burn Hazard: Unplug the power source before replacing lamps. Allow lamps to cool down at least 10 minutes before removing them. Personal injury may result otherwise.

WARNING – Mercury Hazard: Do NOT break UVC lamps. Each UVC lamp contains small amounts of mercury that can have harmful effects if exposed or ingested. Exposure to mercury may cause redness or irritation. In the case of a broken UVC lamp, sweep up the broken glass and debris into a plastic bag and secure it with a tight seal. Dispose of used or broken UVC lamp debris at a local recycling center. Do not use a vacuum cleaner or incinerator to collect or dispose of any lamp debris. Search <http://search.earth911.com/> to find a local recycling agency.

 **PROP65 WARNING:** This product can expose you to chemicals including Di-isodecyl Phthalate, which is known to the State of California to cause cancer and birth defects or other reproductive harm. For more information, go to www.P65Warnings.ca.gov.

IMPORTANT SAFETY INSTRUCTIONS

When using product, basic precautions should always be followed, including the following:

- Read and follow these instructions.
- Heed all warnings, including below warnings AND those included on product.
- Save these instructions and warnings.

- Risk of fire/electric shock.
- Ground fixture to avoid potential electric shock.
- Turn off the power at fuse or circuit breaker box before installation and maintenance.
- Edges may cut. Handle with care.
- Warning signs should be placed at access points to the area being disinfected with UVC light.

CAUTION

- Connect fixture to power source noted on product identification label. Any other connection voids the warranty.
- Fixture should be installed by persons with experience wiring or by a qualified electrician. The electrical system, and the method of electrically connecting the fixture to it, must be in accordance with the National Electrical Code and local building codes.
- This device complies with Part 15 of the FCC Rules. Operation is subject to the following two conditions: (1) This device may not cause harmful interference, and (2) this device must accept any interference received, including interference that may cause undesired operation. **WARNING:** FCC Regulations state that any unauthorized changes or modifications to this equipment not expressly approved by the manufacturer could void the user's authorization to operate this equipment.
- For permanent installation, this UVC product must be combined with a UL certified controls system which will prevent the system from turning on during occupancy.
- UVC products can have adverse effects on other living organisms such as plants and animals.
- UVC light may damage or discolor materials, such as plastics and rubber.
- To clean UVC lamps, disconnect from power and allow them to cool down to room temperature. Wipe the lamp with a slightly damp soft microfiber cloth, using only water. Never spray the lamp with any type of cleaning agent directly.

IMPORTANT DISCLAIMER INFORMATION:

This UVC product is intended as a supplemental disinfectant measure and is not meant to replace manual hygiene processes or other CDC recommended measures. This UVC product can render 99.99% of known pathogens inactivated if directly exposed and used for the proper dose and duration. Note that UVC lights will not disinfect shaded areas or any crevice or areas not directly exposed to the light. *The inactivation of viruses on surfaces may not be effective due to blocking of the UV radiation by soil, such as dust, or other contaminants such as bodily fluids.* Pure UVC products are not approved as a medical device and they are not intended to be used as such or for medical purposes, nor do they prevent, treat, or cure any diseases. Pure UVC products and these statements have not been reviewed by the FDA. **For dosage/duration recommendations specific to your application, please contact Pure Lighting Company at Info@Pure-Lighting.com or (973) 915-3133.**

Pure Lighting does not promise or warrant that the use of the products will protect or prevent any user from infection and/or contamination with any viruses, bacteria, protozoa, fungi, illness or disease. In addition to and without limitation of any exclusions or limitations of liability of Pure Lighting Company as set forth in its terms and conditions of sale, Pure Lighting Company shall have no responsibility or liability whatsoever for any claim or damage that may arise from or relate to any use of the products outside of their intended use. The use of accessory equipment not recommended by the manufacturer may cause an unsafe condition. **Do not use this equipment for other than intended use.**

KEEP OUT OF REACH OF CHILDREN.

Sold by Pure Lighting Company:

150 Pompton Plains Crossroad #4246, Wayne, NJ 07474

Technical and Customer Support: (973) 915-3133.